

## • IMPORTANT SAFETY INSTRUCTIONS

1. Do not mix up the Transmitter and Receiver, and the IR blaster and IR receiver.
2. Do not plug-in/out the cables ,when it is in using.
3. Use DC 12V/3A power supply only. Make sure the specification matched if using 3rd party DC adapters.
4. Support power from transmitter to receiver unit over the CAT6 cable.

## • INTRODUCTION

This HDMI extender splitter (transmitter) works with 4 HDMI CAT6 extender receivers to distribute and extend 1 HDMI source to 4 HDMI displays over single CAT6/6a/7 cable up to 30m/100ft. The highest resolution supported is 4Kx2K@60Hz, and it supports IR passback, only one power adapter for the transmitter is needed, the receiver is powered by the transmitter over CAT6 cable. Ideal solution for HDMI exhibition, video conference and show center, ect.

## • PACKAGE CONTENTS



Transmitter unit x1pc



Receiver unit x4pcs



User Manual x1pc



IR blaster extension cable x1pc

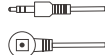

IR receiver extension cable x4pcs



DC12V/3A x1pc

## • FEATURES

1. Plug and play.
2. Support 20~60KHz IR pass back.
3. Support resolution up to 4Kx2K@60Hz.
4. Transmitter support one HDMI loop-out.
5. Wall-mounted function, easy installation.
6. Compatible with CAT6/6a/7 network cables.
7. Support distance up to 30m when 4K@60Hz, 50m when 4K@30Hz and 60m when 1080p@60Hz.
8. Distribute 1 HDMI source to 4 HDMI displays over network cable simultaneously.
9. Can be powered by network cable. It only needs to connect the 12V power on the transmitter unit, both transmitter and receiver start work.

## • INSTALLATION REQUIREMENTS

1. HDMI source device (computer graphics card, DVD, PS3, HD monitoring equipment etc).
2. HDMI display device like SDTV, HDTV, and projector with HDMI port.
3. UTP/STP CAT6/6a/7 cable, follow standard IEEE-568B.

## • PANEL DESCRIPTION

### 1. Transmitter unit (TX)

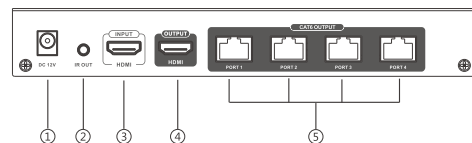

### 2. Receiver unit (RX)

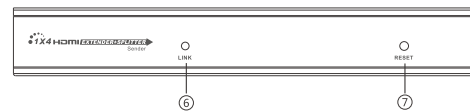

① Power input	Connect with DC12V/3A power adapter
② IR signal output	Connect with IR blaster extension cable
③ HDMI input	Connect with the source device
④ HDMI output	Connect with HDMI display device
⑤ RJ45 signal output	Connect with CAT6 or better cable
⑥ Power/signal indicator	The red light indicates that the power is on. Red light indicates no image transmission, blue light indicates image transmission
⑦ Reset	Press for restarting the unit

### 2. Receiver unit (RX)

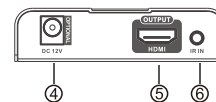
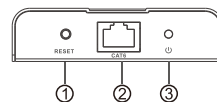

① Reset	Press for restarting the unit
② RJ45 signal input	Connect with CAT6 or better cable
③ Power/signal indicator	The red light indicates that the power is on. Red light indicates no image transmission, blue light indicates image transmission
④ power input	Connect with DC12V/1A power adapter (optional)
⑤ HDMI signal output	Connect with HDMI display device
⑥ IR signal input	Connect with IR receiver extension cable

## • INSTALLATION PROCEDURES

### 1. How to make a CAT6/6A/7 network cable

Follow the standard of IEEE-568B:

- |                 |           |
|-----------------|-----------|
| 1- Orange/white | 2- Orange |
| 3- Green/white  | 4- Blue   |
| 5- Blue/white   | 6- Green  |
| 7- Brown/white  | 8- Brown  |



### 2. Connection

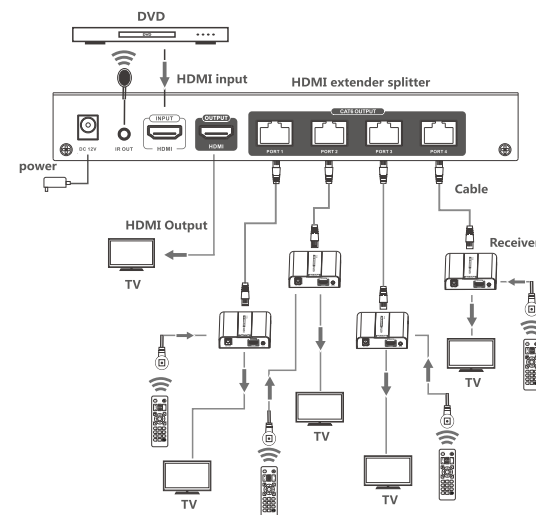

Remarks: Please do not remote control more than one RX unit's IR cable at the same time, to avoid the interference.

### 3. Connection instruction:

- 1) Connect the HDMI signal source device to the transmitter HDMI input port with HDMI cable.
- 2) Connect IR blaster to extender IR output.
- 3) Connect the transmitter RJ45 port to HDMI extender RX's RJ45 input port by network cable.
- 4) Connect HDMI extender RX's HDMI output port to HDMI display's HDMI input port by HDMI cable and set the HDMI display's signal source to be HDMI port.
- 5) Power on this product (The LED indicator turns red when power on, and turns blue when there is a data transmission), the product will work.

### • FAQ

Q : No image or audio output on display ?

- A : 1) Please check whether display on standby mode;  
2) Please make sure the HDMI Port on the HDMI display is correctly connected with the HDMI cable;  
3) Please check the signal indicator LED on RX has turned blue from red;  
4) Please check whether signal indicator LED on TX turns blue, LED on red means no input signal;  
5) Please check and make sure the transmitter input resolution supported by this product.

Q : Image unstable ?

- A : 1) Press transmitter "RESET" button to re-identify the signal;  
2) Please reconnect the network cable of corresponding port.

Q : Only partial ports have output ?

- A : 1) Please check and make sure all the network cable connected well;  
2) Press transmitter "RESET" button to re-identify the signal;  
3) Please reconnect the network cable of corresponding port.

### • SPECIFICATION

Items	Specifications
Input	1 x HDMI
Output	4 x RJ45, 1xHDMI
HDMI signal	HDMI 2.0, compatible HDCP 2.2
Support resolutions	480i@60Hz, 480p@60Hz, 576i@50Hz, 576p@50Hz, 720p@50/60Hz, 1080i@50/60Hz, 1080p@50/60Hz, 3840x2140@30/60Hz
IR signal	Support 20~60KHz IR device
Working temperature	0°C ~ 60°C
Storage temperature	-20°C ~ 70°C
Power supply	DC12V/3A
Power Consumption	TX: <32W RX:<6W
Dimension	TX: 212.6(L) x 102.49(W) x 31.0(H) mm RX: 101.1(L) x 81.6(W) x 20.6(H)mm
Color	Black
Weight	TX : 575g , RX : 190g

## 1×4 HDMI Extender Splitter

User manual

4Kx2K  
60Hz

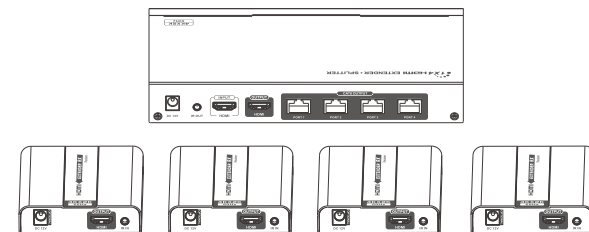

### Disclaimer

The product name and brand name may be registered trademark of related manufactures. ™ and ® may be omitted on the user manual. The pictures in this user manual are just for reference. The terms HDMI, HDMI High-Definition Multimedia Interface, and the HDMI Logo are trademarks or registered trademarks of HDMI Licensing Administrator, Inc. We reserve the rights to make changes without further notice to a product or system described herein to improve reliability, function or design.

**HDMI**™  
HIGH-DEFINITION MULTIMEDIA INTERFACE