

INSTALLATION INSTRUCTIONS

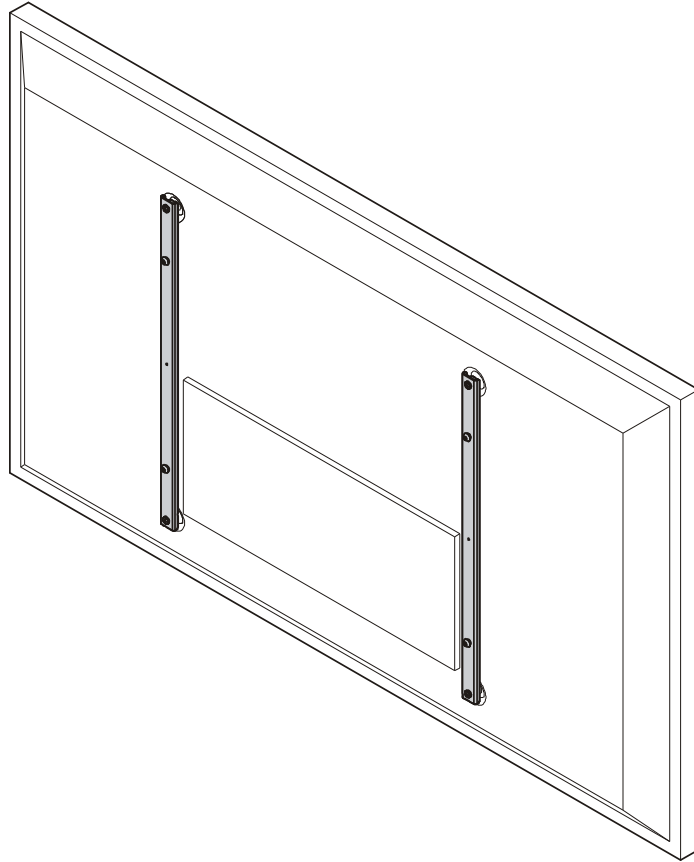

Flat Panel Interface Bracket

DISCLAIMER

Milestone AV Technologies and its affiliated corporations and subsidiaries (collectively "Milestone"), intend to make this manual accurate and complete. However, Milestone makes no claim that the information contained herein covers all details, conditions or variations, nor does it provide for every possible contingency in connection with the installation or use of this product. The information contained in this document is subject to change without notice or obligation of any kind. Milestone makes no representation of warranty, expressed or implied, regarding the information contained herein. Milestone assumes no responsibility for accuracy, completeness or sufficiency of the information contained in this document.

Chief® is a registered trademark of Milestone AV Technologies. All rights reserved.

! IMPORTANT SAFETY INSTRUCTIONS

! WARNING: A WARNING alerts you to the possibility of serious injury or death if you do not follow the instructions.

! CAUTION: A CAUTION alerts you to the possibility of damage or destruction of equipment if you do not follow the corresponding instructions.

! WARNING: Failure to read, thoroughly understand, and follow all instructions can result in serious personal injury, damage to equipment, or voiding of factory warranty! It is the installer's responsibility to make sure all components are properly assembled and installed using the instructions provided.

! WARNING: Failure to provide adequate structural strength for this component can result in serious personal injury or damage to equipment! It is the installer's responsibility to make sure the structure to which this component is attached can support five times the combined weight of all equipment. Reinforce the structure as required before installing the component.

! WARNING: Exceeding the weight capacity can result in serious personal injury or damage to equipment! It is the installer's responsibility to make sure the combined weight of all components located between the FHB3037/5037/7037 up to (and including) the display does not exceed the weight limit of the mount to which it is being attached.

! WARNING: Use this mounting system only for its intended use as described in these instructions. Do not use attachments not recommended by the manufacturer.

! WARNING: Never operate this mounting system if it is damaged. Return the mounting system to a service center for examination and repair.

! WARNING: Do not use this product outdoors.

--SAVE THESE INSTRUCTIONS--

DIMENSIONS

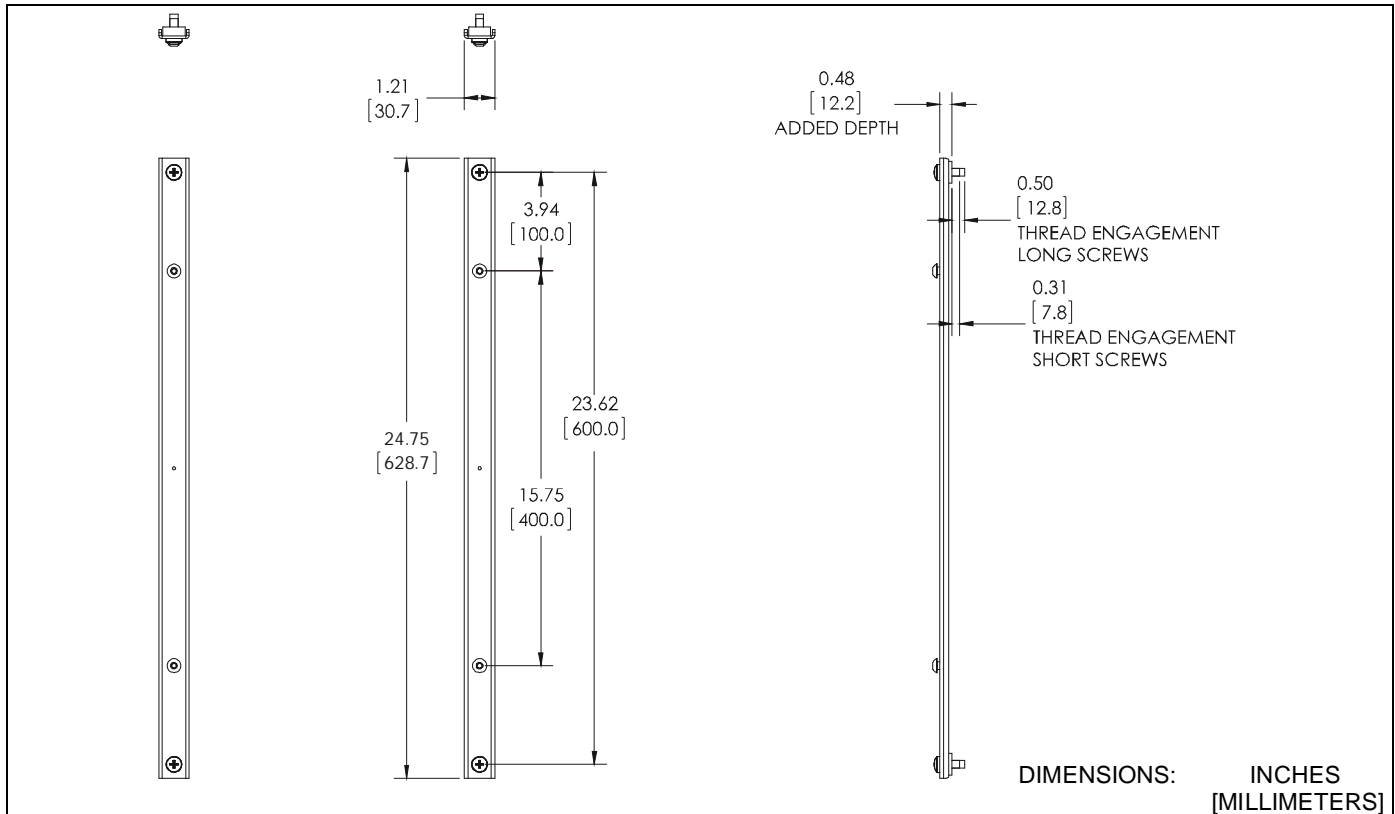

TOOLS / PARTS FOR INSTALLATION

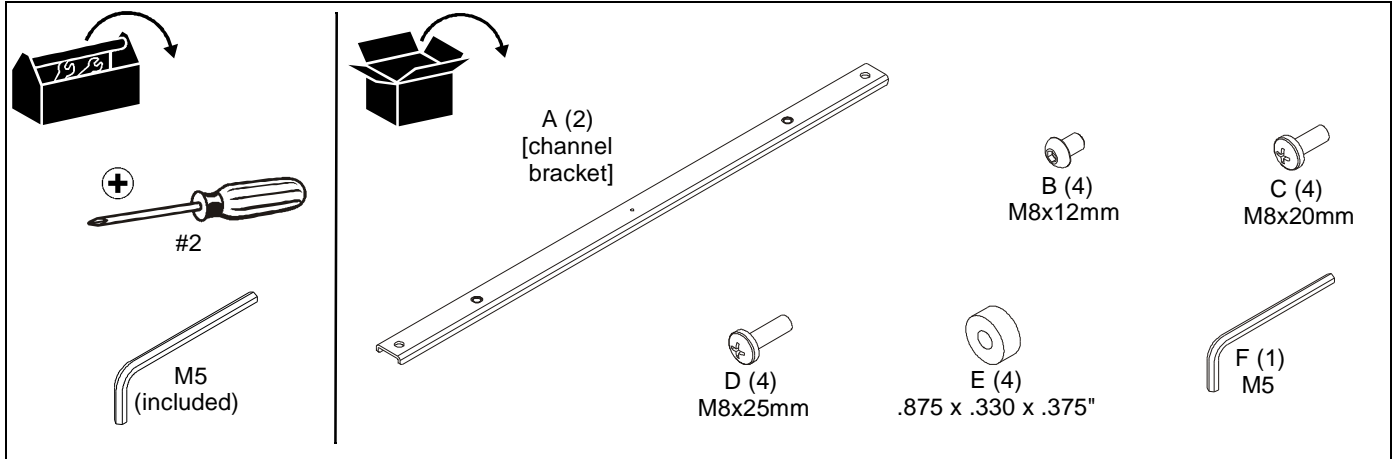

ASSEMBLY AND INSTALLATION

1. Install wall mount to wall following mount instructions up until the interface brackets are to be attached to the display.
2. Lay display face down on a protective surface.
3. Position two spacers (E) over two holes on back of display. (See Figure 1)



WARNING: IMPROPER INSTALLATION CAN LEAD TO DISPLAY FALLING CAUSING SERIOUS PERSONAL INJURY OR DAMAGE TO EQUIPMENT! Using screws of improper size may damage your display. Properly sized screws will easily and completely thread into display mounting holes.

4. Install two M8 x 25mm Phillips head cap screws (D) **OR** two M8 x 20mm Phillips head cap screws (C) through channel bracket (A), spacer (E) and into back of display. (See Figure 1)

NOTE: Use alignment hole in channel brackets to line up the wall mount interface brackets for a vertically centered mount. (See Figure 2)

5. Use two M8 x 12mm button head screws (B) to secure wall mount interface bracket to channel bracket (A). (See Figure 1)
6. Repeat Steps 3-5 for other channel bracket.

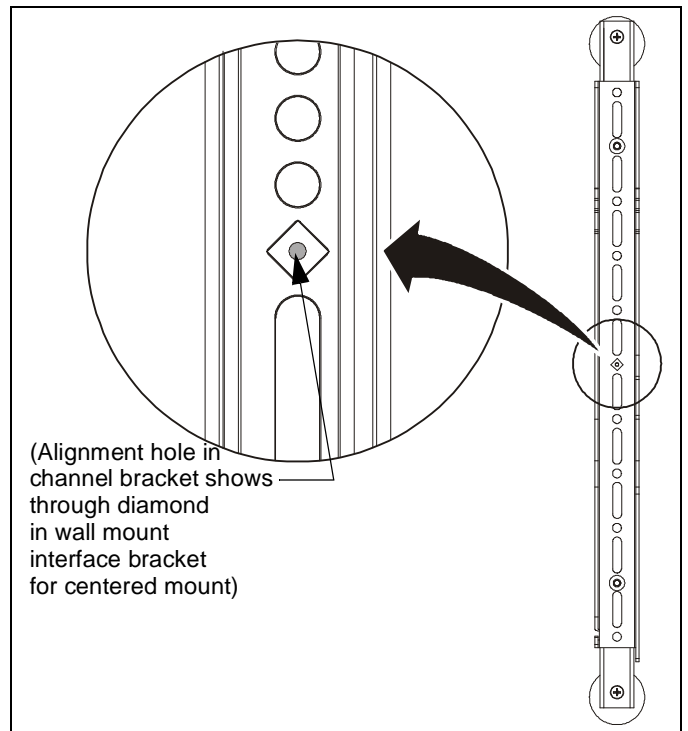

Figure 2

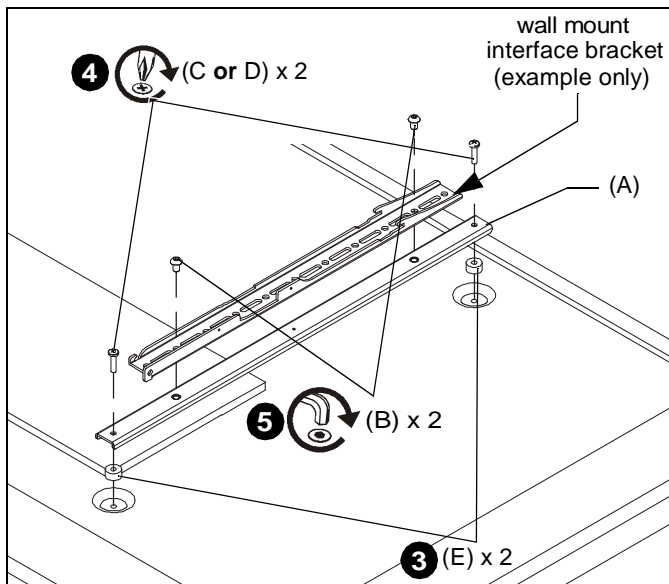

Figure 1

7. Complete the installation following the mount installation instructions.



Our Mounts. **Your Vision.**

Chief, a products division of
Milestone AV Technologies

8800-002599 Rev00
©2014 Milestone AV Technologies
www.chiefmfg.com
06/14

USA/International	A 6436 City West Parkway, Eden Prairie, MN 55344
	P 800.582.6480 / 952.225.6000
	F 877.894.6918 / 952.894.6918
Europe	A Franklinstraat 14, 6003 DK Weert, Netherlands
	P +31 (0) 495 580 852
	F +31 (0) 495 580 845
Asia Pacific	A Office No. 918 on 9/F, Shatin Galleria 18-24 Shan Mei Street Fotan, Shatin, Hong Kong
	P 852 2145 4099
	F 852 2145 4477

